

# RoboScrub 20 Operations Manual



# INTRODUCTION

This operator manual is provided with each new model and contains information to allow for quick start-up of your new Minuteman® RoboScrub 20, powered by BrainOS. This manual may be periodically updated or revised. The RoboScrub 20 can be used in manual mode or in robotic (self-driving/autonomous) mode. Use in robotic mode requires a subscription to Brain Corp's Autonomy Services. Follow all provided instructions and warnings. Failure to adhere to directions could result in damage to the machine and injury to the operator and public.

Brain Operating System (BrainOS) is the name of Brain Corp's artificial intelligence (AI) and autonomous navigation software that provides robotic operating capabilities to the RoboScrub 20.

## MINUTEMAN® ROBOSCRUB 20 DESCRIPTION

The Minuteman® RoboScrub 20 is a commercial floor scrubber that is powered by BrainOS software. The RoboScrub 20 is capable of functioning in either manual or robotic mode. When in robotic mode, the RoboScrub 20 is driven by the BrainOS navigation software. This manual uses the term robotic mode, which is equivalent to autonomous mode.

The RoboScrub 20 may be covered by one or more patents or pending patent applications. See [www.braincorporation.com/patents](http://www.braincorporation.com/patents) for details. Discrete portions of this product were made possible by open source software. See [www.braincorp.com/open-source-attributions](http://www.braincorp.com/open-source-attributions) for details.

## INTENDED USE AND PRECAUTIONS

The RoboScrub 20 is a collaborative robot that is intended for supervised commercial use. Use the RoboScrub 20 exclusively on hard floors in an indoor environment. Do not use on soil, grass, artificial turf, or carpeted surfaces. Only use the RoboScrub 20 with accessories approved by Brain Corp. The RoboScrub 20 should only be used by operators trained by Brain Corp or Brain Corp-approved trainers in a controlled, restricted environment approved by Brain Corp.

Additional training materials may be provided as to the intended use of the RoboScrub 20, and it should only be used in accordance with such training. Use the machine in approved environments in accordance with the Autonomy Services Agreement (ASA) and the Autonomous Navigation Software End User License Agreement (EULA).

The operator is responsible for the use of the RoboScrub 20 in both manual and robotic mode. Therefore, each operator must be mindful to use the machine in accordance with its intended use, precautions, and warnings at all times. Operators will not engage in any of the following conduct or activities with respect to Autonomy Services or BrainOS:

- a) Transmission of any software or other materials that contain any viruses, worms, trojan horses, defects, spyware, spiders, screen-scrapers, or other items of a destructive or disruptive nature;
- b) Exploitation of the Autonomy Services, BrainOS, or the machine's hardware in any unauthorized manner, including trespassing or burdening server or network capacity or infrastructure;
- c) Framing, mirroring, or reselling any part of the Autonomy Services or BrainOS without Brain Corp's prior written authorization;
- d) Unauthorized collection of user information;
- e) Attempting to deliberately damage or undermine the legitimate operation of the Autonomy Services or BrainOS;
- f) The machine's onboard cameras may capture images of people who happen to be in its surrounding. There may be additional jurisdictional laws of operation relating to use of technology with cameras. Please comply with all applicable laws, including using signage or obtaining consents as required.

# TECHNICAL SPECIFICATIONS

MODEL	MINUTEMAN MAX RIDE 20 (A-MR20)
DIMENSIONS WITH SQUEEGEE	47.5 IN LENGTH X 29 IN WIDTH X 45 IN HEIGHT (120.65 CM X 73.66 CM X 114.3 CM)
WEIGHT	342 LBS (155.13 KG)
WEIGHT WITH BATTERIES AND FULL SOLUTION	691 LBS (313.43 KG)
SOLUTION TANK CAPACITY	18 GAL (68.14 L)
CLEANING PATH WIDTH	20 IN (50.8 CM)
SQUEEGEE WIDTH	26.75 IN (67.95 CM)
APPROXIMATE PRODUCTIVITY RATE (MANUAL OPERATION)	22,015 SQ FT/HR (2,045.26 SQ M/HR)
MAXIMUM PRODUCTIVITY RATE (MANUAL OPERATION)	27,200 SQ FT/HR (2,526.96 SQ M/HR)
MAXIMUM SPEED	2.0 MPH (3.2 KPH) ROBOTIC; 3.1 MPH (5 KPH) MANUAL
SCRUB HEAD TYPE	DISC
BRUSH PRESSURE	60 LBS (27.22 KG)
BRUSH MOTOR	400 – 600 WATTS
BRUSH SPEED	175 – 400 RPM
SOLUTION FLOW (LOW to HIGH)	0.07 – 0.38 GPM (0.27 – 1.44 LPM)
VACUUM MOTOR	24 VDC/450 WATTS
VACUUM AIRFLOW	69 CFM (32.56 L/SEC)
VACUUM WATERLIFT	68 IN H <sub>2</sub> O (172.72 CM H <sub>2</sub> O)
SOUND PRESSURE/DECIBEL RATING	68 DBA
BATTERIES	(2) 12 V AGM SEALED, MAINTENANCE-FREE
BATTERY CHARGER	ONBOARD
MAXIMUM RUN TIME	UP TO 3 – 3.5 HOURS
MACHINE VOLTAGE	24 VDC/450 WATTS
MAXIMUM INCLINE/DECLINE GRADE LEVEL	0% ROBOTIC; 2% MANUAL
APPROVALS	NONE
IP PROTECTION CLASS	IPX4

# CONTENTS

- INTRODUCTION ..... 2
- TECHNICAL SPECIFICATIONS ..... 3
- IMPORTANT SAFETY INSTRUCTIONS ..... 8
  - GENERAL SAFETY ..... 8
  - ENVIRONMENTAL SAFETY ..... 8
  - OPERATIONAL SAFETY ..... 9
  - MAINTENANCE AND SERVICE SAFETY ..... 10
- ROBOSCRUB 20 OVERVIEW ..... 11
- COMPONENTS OVERVIEW ..... 14
  - SOLUTION FILL PORT AND FILTER ..... 14
  - SOLUTION TANK SITE GAUGE/DRAIN HOSE ..... 14
  - WARNING LIGHT ..... 14
  - EMERGENCY STOP ..... 15
  - START/PAUSE ..... 15
  - BATTERY COMPARTMENT ..... 15
  - RECOVERY TANK DRAIN HOSE ..... 16
  - RECOVERY TANK SCREENED FLOAT ..... 16
  - OPERATOR SEAT/TANK LID ..... 16
  - ACCELERATOR PEDAL ..... 17
  - SENSORS ..... 17
- CONTROL CONSOLE OVERVIEW ..... 18
  - USER INTERFACE (UI) TOUCH SCREEN ..... 18
  - IGNITION KEY SWITCH ..... 19
  - HORN BUTTON ..... 19
  - SOLUTION TANK LOW INDICATOR ..... 19
  - RECOVERY TANK HIGH INDICATOR ..... 19
  - SOLUTION FLOW CONTROL ..... 19
  - DIRECTION BUTTONS (FORWARD/BACKWARD) ..... 20
  - VACUUM BUTTON ..... 20
  - ONE-TOUCH BUTTON ..... 20

# CONTENTS

- ROBOSCRUB 20 SETUP ..... 21
  - UNPACK ROBOSCRUB 20 ..... 21
  - SCRUB BRUSH/PAD OPTIONS ..... 22
  - INSTALL SCRUB BRUSH/PAD ..... 23
  - UNLOAD SCRUB BRUSH/PAD ..... 23
  - LOAD SCRUB BRUSH/PAD ..... 23
  - SQUEEGEE ASSEMBLY ..... 24
  - INSTALL AND ADJUST SQUEEGEE ..... 25
  - INSTALL/REPLACE SQUEEGEE BLADE ..... 25
  - ADJUST SQUEEGEE HEIGHT ..... 25
  
- BEFORE USE ..... 26
  
- MANUAL OPERATION ..... 27
  
- ROBOTIC OPERATION ..... 28
  - ROBOTIC MODE OPERATION ..... 28
  - ESTABLISH HOME MARKERS ..... 28
  - REGION ..... 29
  - ROC: ROBOT OPERATIONS CENTER ..... 30
  - PAIR A PHONE TO THE ROC ..... 30
  - TEACH A ROBOTIC ROUTE ..... 31
  - RUN A ROBOTIC ROUTE ..... 35
  - ALERTS DURING OPERATION ..... 38
  - EMERGENCY STOP ..... 41
  - DELETE A ROUTE ..... 42
  
- AFTER USE ..... 44
  - AFTER USE DAILY TASKS ..... 44
  - DRAIN AND CLEAN TANKS, HOSES, AND FILTERS ..... 44
  - CLEAN SCRUB BRUSH/PAD ..... 44
  - CLEAN SQUEEGEE ..... 44
  - CLEAN IN-LINE SOLUTION FILTER ..... 45
  - PARK AND POWER DOWN ..... 46
  - ROBOSCRUB 20 STORAGE ..... 46

# CONTENTS

- BATTERY CHARGING..... 47
- BRAKE RELEASE ..... 48
- MAINTENANCE & SAFETY ..... 49
  - DAILY MAINTENANCE..... 49
  - DRAIN AND CLEAN TANKS, HOSES, AND FILTERS ..... 49
  - CLEAN SENSORS ..... 49
  - CLEAN SCRUB BRUSH/PAD ..... 50
  - CLEAN SQUEEGEE ..... 50
  - PARK AND STORE RoboScrub 20..... 50
  - CHARGE BATTERIES ..... 51
  - WEEKLY MAINTENANCE ..... 52
  - MONTHLY MAINTENANCE ..... 52
  - YEARLY MAINTENANCE..... 52
  - PERIODIC MAINTENANCE ..... 53
- TROUBLESHOOTING & SUPPORT..... 54
  - ROBOSCRUB 20 FAQs ..... 54
  - TROUBLESHOOTING TIPS ..... 55
  - WHERE TO GET MAINTENANCE AND SUPPORT ..... 57
- WARRANTY..... 58



# IMPORTANT SAFETY INSTRUCTIONS

## GENERAL SAFETY

The Minuteman® RoboScrub 20 is designed solely for scrubbing dirt and dust in a commercial, indoor environment. Do not use this RoboScrub 20 in any other capacity. The following situations could cause injury to the operator and/or RoboScrub 20. Read this manual carefully and use caution when these conditions exist.

- Operators must be appropriately trained on the use of the RoboScrub 20.
- Operators must read and understand this manual before operating or maintaining the RoboScrub 20.
- Train all personnel who will be operating the RoboScrub 20. The RoboScrub 20 is not intended for users with reduced physical, sensory, or mental capabilities, nor by untrained users.
- Report any damage or faulty operation immediately. Do not use the RoboScrub 20 if it is damaged in any way.
- Avoid moving parts.
- Do not allow children to play with the RoboScrub 20.
- Do not use the RoboScrub 20 in a manner other than what is described in this manual.
- Do not clean with a pressure washer.
- Only plug the external charger into an outlet with an appropriate electrical rating: 100 to 240V, 50/60 Hz, 8 A. In North America, the standard grounded outlet emits 120V, which is in the appropriate electrical rating.
- Do not disconnect the offboard charger's DC cord from the machine's receptacle when the charger is operating. Arcing may result. If battery charging must be interrupted, disconnect the AC power supply cord first.
- Do not pull on the battery charger cord to unplug. Grasp plug at outlet and pull.
- Only use approved batteries and chargers. Use of unapproved parts may impair safety and potentially damage the machine and/or cause a fire.

## ENVIRONMENTAL SAFETY

- The RoboScrub 20 is not designed or intended for use in environments requiring fail-safe performance including, but not limited to any application in which failure of the RoboScrub 20 could lead directly to death, personal injury, or severe physical or property damage.
- Do not use on soil, grass, artificial turf, or carpeted surfaces.
- Indoor use only.
- Do not use on public paths or roads.
- The RoboScrub 20 should only be used to scrub flat, hard surfaces with little to no inclines (up to 2% incline when operating in manual mode; 0% incline when operating in robotic mode).
- All drops, stairs, escalators, moving platforms, or cliffs near the RoboScrub 20 must be guarded by a physical barrier when operating in robotic mode.
- Do not use temporary elevated platforms (e.g. ladders or scaffolds) near the RoboScrub 20 during operation.
- Do not leave electrical cords or low-profile items (e.g. items with a height of less than 7 inches [18 centimeters] from the ground) in the RoboScrub 20's area of operation.
- Place Wet Floor signs in areas where the RoboScrub 20 is operating. See the ASA and EULA for further uses and restrictions.



# IMPORTANT SAFETY INSTRUCTIONS

- Operating and storage temperature is 35°F - 100°F (2°C - 38°C).
- Store indoors in a dry environment.
- Use caution when moving the RoboScrub 20 into or out of areas that are below freezing temperatures. Any water in the tanks or hoses can cause damage to the RoboScrub 20.
- Park and store the RoboScrub 20 on a level surface only.
- Some objects may be difficult for the RoboScrub 20 to detect, such as diffusive black finishes, highly polished/reflective surfaces, or Plexiglas. Avoid cleaning in robotic mode where these objects are present.
- Avoid using the RoboScrub 20 in proximity to other products that are sensitive to electromagnetic noise.
- Do not use in low traction environments (e.g. ice, oil, etc.).
- Avoid use in environments where stopping could result in a safety risk, such as blocking an emergency exit.
- Avoid use in environments with inconsistent terrain texture (excessively bumpy) or many floor transitions.

## OPERATIONAL SAFETY

- Keep hands and feet clear of moving parts while the RoboScrub 20 is in operation.
- Locate and make sure all safety devices (e.g. operator seat sensor, yellow safety straps, and emergency stop buttons) are in place and fully functional.
- All doors and covers must be positioned as indicated in the instruction manual before using the RoboScrub 20.
- Keep all third parties, especially children and animals, at least 3 feet away from the machine during operation.
- The operator is responsible for supervising and monitoring safe operation of the RoboScrub 20.
- Do not ride the RoboScrub 20 when it is operating in robotic mode.
- Do not grab the steering wheel when operating in robotic mode, as it may move rapidly and unexpectedly.
- All wheels/tires always need to be in contact with the floor. Avoid abrupt maneuvers while using in manual mode.
- Do not use flammable cleaning agents.
- Do not operate the RoboScrub 20 near flammable materials such as solvents, thinners, fuels, grain dust, etc. Electric motors and components can cause an explosion when operated near explosive materials or vapors.
- The RoboScrub 20 is not suitable for picking up hazardous substances.
- Use appropriate personal protective equipment, as recommended by the cleaning chemical safety data sheet, when adding cleaning chemicals or draining fluids.
- Observe the legal directives and local regulations for disposal of cleaning chemicals or detergents.
- In case of accidental contact or spillage of cleaning chemicals or detergents, follow guidelines provided by the manufacturer.
- Only use the brush/pad provided with the RoboScrub 20 or those specified by Brain Corp or Minuteman. Use of unauthorized brushes/pads may impair safety and potentially damage the RoboScrub 20.
- Do not leave the RoboScrub 20 unattended without first turning the ignition key off and removing the key. When the RoboScrub 20 is operating in robotic mode, remove the ignition key to prevent unauthorized use.

# IMPORTANT SAFETY INSTRUCTIONS

- Drain all tanks and hoses prior to storing the RoboScrub 20.
- Prevent unauthorized use of the RoboScrub 20 by storing with the ignition key removed.
- Do not charge batteries when open flames or sparks are present. Do not smoke.
- If the battery charger or power supply cord is damaged, it must be replaced. Do not use damaged parts.

## MAINTENANCE AND SERVICE SAFETY

- Repairs and specified maintenance tasks must be performed by authorized personnel only.
- Only use approved replacement parts. Use of unapproved parts may impair safety and potentially damage the machine.
- Read all instructions before performing any service or maintenance function.
- Take precautions to prevent hair, jewelry, or loose clothing from becoming caught in moving parts.
- Only work on the machine when it is parked on a level surface and appropriately stabilized via safety blocks or support stands, if necessary.
- Do not lay tools or metal objects on top of the batteries.
- Remove all jewelry, watches, and other conductive materials when working near electrical components.
- Dispose of depleted batteries that can no longer be recharged in accordance with your local environmental regulations.

# ROBOSCRUB 20 OVERVIEW



1. Sensors: Side 2D Cameras
2. Sensors: Front 2D Camera
3. Sensors: Front 3D Camera
4. Sensors: Side 3D Cameras
5. Sensors: Lower LIDAR
6. Front Bumper Skirt
7. Front Drive Wheel

8. Scrub Deck
9. Squeegee
10. Accelerator Pedal
11. Solution/Recovery Tank
12. Operator Seat/Recovery Tank Lid
13. Sensors: Upper LIDAR

# ROBOSCRUB 20 OVERVIEW

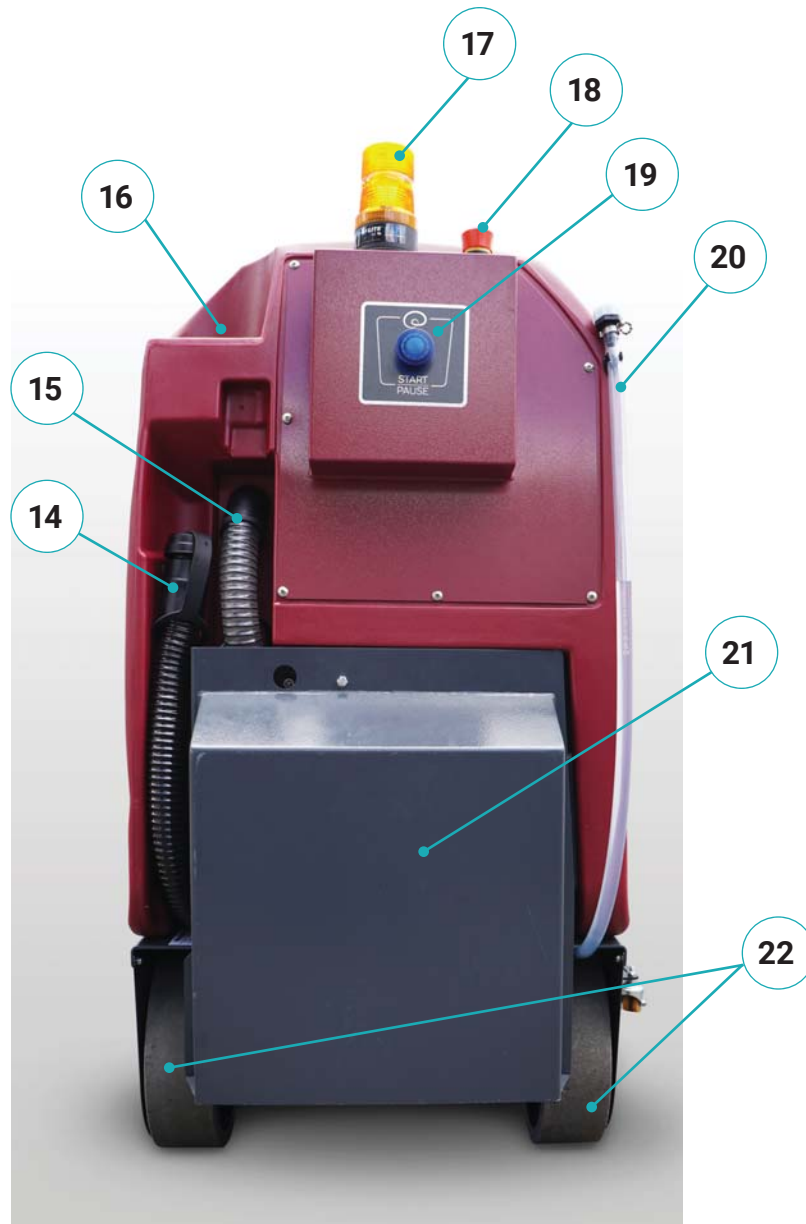

- 14. Recovery Tank Drain Hose
- 15. Vacuum Motor Muffler
- 16. Solution Fill Port
- 17. Warning Light
- 18. Rear Emergency Stop
- 19. Start/Pause Button
- 20. Solution Tank Site Gauge/Drain Hose
- 21. Battery Compartment
- 22. Rear Tires

# ROBOSCRUB 20 OVERVIEW



- 23. Ignition Key Switch
- 24. User Interface (UI) Touch Screen
- 25. Steering Wheel
- 26. Front Emergency Stop
- 27. Horn Button
- 28. Recovery Tank High Indicator
- 29. Solution Tank Low Indicator
- 30. Solution Flow Control
- 31. One-Touch Button
- 32. Vacuum Button
- 33. Direction Buttons (Forward/Backward)

# COMPONENTS OVERVIEW

## COMPONENTS OVERVIEW

There are a number of physical components that play a vital role in floor scrubbing, as well as robotic operation. Familiarize yourself with all components and controls before using the RoboScrub 20.

### SOLUTION FILL PORT AND FILTER



The solution fill port is where you pour a premixed solution of an approved cleaning chemical and clean water. The solution tank can hold up to 18 gallons (68 liters). Use appropriate personal protective equipment and pour the premixed solution into the solution fill port. Use the solution tank site gauge to guide you as you pour. Do not overfill.

### SOLUTION TANK SITE GAUGE/DRAIN HOSE



The solution tank site gauge/drain hose serves two purposes: as a visual indicator of the solution tank volume and is used to drain the solution tank. Using appropriate personal protective equipment, drain the solution tank by removing the hose from the clip, removing the cap at the top of the hose, and lowering the hose to drain.

### WARNING LIGHT



The warning light flashes when the RoboScrub 20 is operating in robotic mode. This serves as an indicator to passersby that the RoboScrub 20 is currently in operation.

# COMPONENTS OVERVIEW

## EMERGENCY STOP



The RoboScrub 20 is equipped with two emergency stop buttons, one on the rear and one on the control console. The emergency stop buttons should only be used in emergency situations, as this potentially releases all fluids onto the floor causing a slipping hazard. When one of the emergency stop buttons is pressed, all scrubber functions are immediately stopped and the in-process robotic route is terminated.

## START/PAUSE



The RoboScrub 20 is equipped with a blue start/pause button on the back that is used to begin running a saved route in robotic mode, or to pause an in-process robotic route. When pressed, the scrub brush raises. The squeegee stays down and the vacuum remains on for approximately 20 seconds, after which the vacuum turns off and the squeegee raises. Always use the start/pause button to pause a robotic route for standard, non-emergency situations.

## BATTERY COMPARTMENT



The battery compartment houses the batteries, battery connections, and the onboard charger. See [UNPACK ROBOSCRUB 20](#) and [BATTERY CHARGING](#) for details.



# COMPONENTS OVERVIEW

## RECOVERY TANK DRAIN HOSE



The recovery tank drain hose is used to drain the recovery tank. Use appropriate personal protective equipment to drain the recovery tank by removing the hose from the clip, removing the cap at the top of the hose, and lowering the hose to drain.

## RECOVERY TANK SCREENED FLOAT



Inside the recovery tank is a screened float. When the recovery tank is overfilled or a large amount of foaming is present, the screened float blocks the vacuum intake inside the tank protecting the vacuum motor and internal electronics from water damage. It is essential to keep the screened float clean and functioning properly.

## OPERATOR SEAT/TANK LID

The operator seat is equipped with two sensors: a pressure switch under the seat cushion to prevent joyriding during robotic operation, and two contact switches located on the back of the seat and the body of the RoboScrub 20. It also serves as the recovery tank lid.





# COMPONENTS OVERVIEW

## ACCELERATOR PEDAL



Pressing the accelerator pedal moves the RoboScrub 20 forward or backwards, depending on which direction switch is selected on the control console. The amount of pressure placed on the accelerator pedal controls the speed. When pressure is completely removed, the electromagnetic brake automatically engages, stopping the RoboScrub 20.

## SENSORS



The RoboScrub 20 is equipped with LIDAR, 3D and 2D cameras, all of which allow machine vision for the robotic software. All sensors and cameras constantly surveil the robot's surroundings for both stationary and moving obstacles. When an obstacle is detected, the RoboScrub 20 will attempt to navigate around it and continue on its robotic map.

# CONTROL CONSOLE OVERVIEW

## CONTROL CONSOLE OVERVIEW

The Minuteman® RoboScrub 20, powered by BrainOS, was designed with total operator ease of use in mind. All controls and components have been designed as a total system to efficiently clean dirty floors. The control console consists of the User Interface (UI) Touch Screen, also referred to as the UI or touch screen, and a number of manual controls.

Before using the RoboScrub 20, familiarize yourself with all components and controls.

## USER INTERFACE (UI) TOUCH SCREEN

The RoboScrub 20 is equipped with BrainOS software that is accessible via the User Interface (UI) Touch Screen, located on the left side of the control console. BrainOS technology offers a robotic mode feature that provides the ability for the RoboScrub 20 to perform floor cleaning by following one of the saved navigation routes without direct, real-time operator control. When the Minuteman® RoboScrub 20 is turned on, the BrainOS software will automatically initialize (as shown to the right).

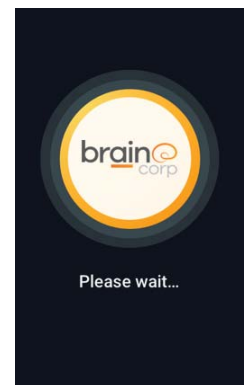

Once the BrainOS software has initialized, it is ready for use. The top of the touch screen displays the current time, battery life, and ROC connection status. In addition, the touch screen allows an operator to run an existing cleaning route robotically, teach a new cleaning route, and access to a variety of settings. See [ROBOTIC OPERATION](#) for details.

# CONTROL CONSOLE OVERVIEW

## IGNITION KEY SWITCH



Just below the steering wheel is the ignition key switch. The ignition key switch turns the RoboScrub 20 on and off. Turn the key to the right (clockwise) to turn on the RoboScrub 20. Turn the key to the left (counter-clockwise) to turn it off. In addition, the ignition key is used to unload the scrub brush when the key is turned to the left (counter-clockwise), past the off position. See [UNLOAD SCRUB BRUSH/PAD](#) for details.



## HORN BUTTON

Pressing this button sounds the RoboScrub 20's horn.



## SOLUTION TANK LOW INDICATOR

When illuminated, indicates that the solution tank is low and needs to be refilled.



## RECOVERY TANK HIGH INDICATOR

When illuminated, indicates that the recovery tank level is high and needs to be emptied.



## SOLUTION FLOW CONTROL

The solution flow control regulates the amount of solution that is discharged during cleaning. This control returns to default factory settings (lowest setting) every time the RoboScrub 20 is turned on, as cleaning needs may change from day-to-day. Before using, manually adjust the solution flow control to the desired setting for optimum cleaning performance.

# CONTROL CONSOLE OVERVIEW

## DIRECTION BUTTONS (FORWARD/BACKWARD)



The direction buttons control whether the RoboScrub 20 drives forward or backward when the accelerator pedal is pressed. The upward arrow instructs the RoboScrub 20 to drive forward. The downward arrow instructs it to drive backward. When driving backward, the squeegee will automatically raise to prevent damage. Be sure to inspect the floor for any residual water after driving backward.



## VACUUM BUTTON

Pressing the vacuum button turns the vacuum on. When the vacuum is turned on, the squeegee automatically lowers when driving forward. When the vacuum is turned off, the squeegee will stay down for approximately 8 seconds and then raise. The vacuum motor will run for approximately 15 seconds and then turn off.



## ONE-TOUCH BUTTON

The one-touch button engages the scrub brush, vacuum, and squeegee, allowing for immediate operation of the RoboScrub 20. When pressed, the scrub brush and squeegee are lowered, and the vacuum turns on. When scrubbing is complete, press the one-touch button again to disengage cleaning operations. The scrub brush will rise off the floor. The squeegee will remain down for a few seconds and then rise as well. After the squeegee has risen, the vacuum will remain on for a few additional seconds to clear any remaining water in the hose and then turn off.

# ROBOSCRUB 20 SETUP

## UNPACK ROBOSCRUB 20

Check the packing crate for any damage, and immediately report any damage to the delivery carrier. To unpack the crate:

1. Remove plastic.
2. Remove box containing all robotic (autonomous) equipment and review contents to ensure all items are included.
3. Remove the walls from the pallet.
4. Remove the battery cover located on the back of the RoboScrub 20.
5. The RoboScrub 20 is battery-operated and designed to operate on 24 volts DC; (2) 12 volt batteries. If necessary, insert both batteries.

**Recommended Battery Specifications: (2) 12 V  
Discover Dry Cell Traction Valve Regulated Battery,  
Model EV185A-A**

**NOTE:** MINUTEMAN RECOMMENDS THAT ONLY TRAINED FIELD TECHNICIANS OR MAINTENANCE STAFF INSTALL OR REPLACE BATTERIES. IMPROPER BATTERY INSTALLATION CAN CAUSE RISK TO USERS AND THE MACHINE.

6. Remove the tape from the two red battery connectors and attach them together.
7. Place the battery compartment cover back in position.

8. Remove the chock strips, squeegee straps, and straps needed to secure the ramp.
9. Remove the ramp attached to the back of the pallet.
10. Use the supplied straps to secure the ramp to the rear of the pallet.
11. Make sure the area behind the pallet is clear.
12. Remove the key that is strapped to the steering wheel.
13. Sit on the operator seat, insert the ignition key and turn to the right (clockwise) to start the RoboScrub 20.
14. Make sure the squeegee and scrub deck are raised.
15. Press the downward direction button arrow.
16. Slowly drive the machine backwards off the ramp.

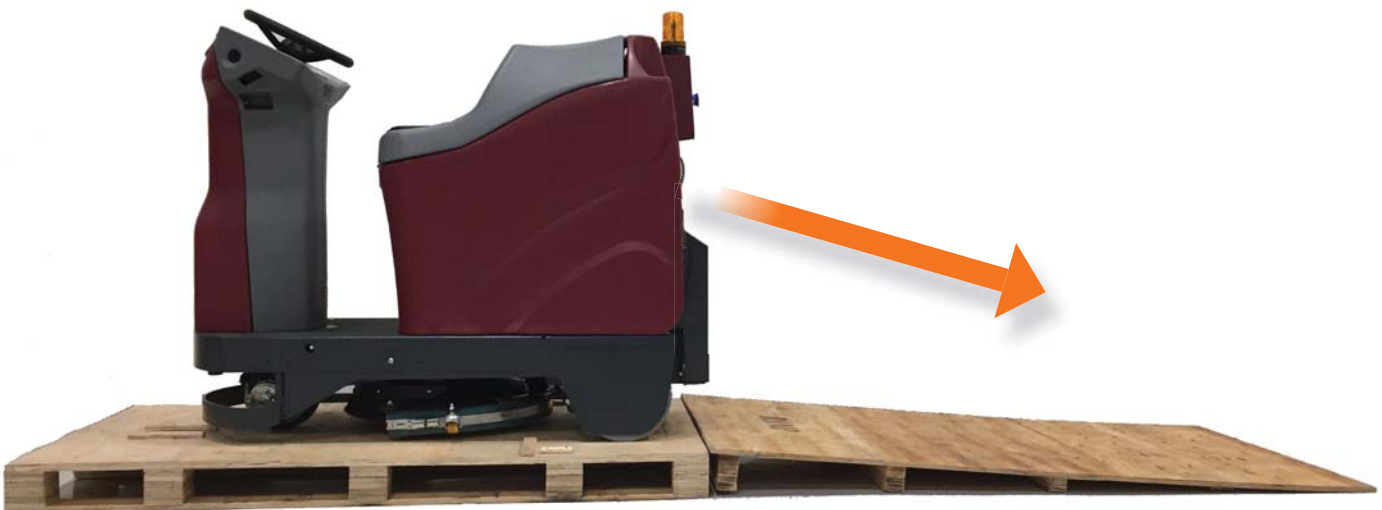

# ROBOSCRUB 20 SETUP

## SCRUB BRUSH/PAD OPTIONS

The following scrub brush or pad options are available with the Minuteman® RoboScrub 20, powered by BrainOS:

PART #	DESCRIPTION
172520-1	BRUSH-DISC, 20" NYLON, BLACK
172520-3	BRUSH-DISC, 20" NYLO-GRIT 80GR, BLACK
172520-6	BRUSH-DISC, 20" SCRUB GRIT 2, 120GR RED
172588	PAD DRIVER, ASSY, AQUASTOP, 20" ( <b>STANDARD</b> )
762370	PAD RETAINER-REMOVABLE-NOT SHOWN
762394	PAD RETAINER-FIXED-NOT SHOWN
<b>AQUASTOP BRUSHES</b>	
7951-01	BRUSH, 20" LIGHT-MEDIUM PP.5 A/S, WHITE
7951-02	BRUSH, 20" LIGHT-MEDIUM A/S, K901, BLACK
7951-03	BRUSH, 20" MEDIUM NYLON 600GR A/S, GREY
7951-04	BRUSH, 20" MEDIUM-HEAVY PP.8 A/S, WHITE
7951-05	BRUSH, 20" HEAVY NYLON 180 GR A/S, GREY
7951-06	BRUSH, 20" HEAVY-2 NYLON 120GR A/S, GREEN

# ROBOSCRUB 20 SETUP

## INSTALL SCRUB BRUSH/PAD

The Minuteman® RoboScrub 20, powered by BrainOS, is typically shipped with a scrub brush attached.

### UNLOAD SCRUB BRUSH/PAD

If there is a brush currently attached, perform the following steps to unload the scrub brush/pad:

1. Turn the ignition key to the left (counter-clockwise) to turn the RoboScrub 20 off, if necessary.
2. Turn the ignition key to the left (counter-clockwise) past the off position and hold.
  - a. The scrub brush/pad will spin for a moment and then release.
  - b. Remove the scrub brush/pad from underneath the RoboScrub 20.
3. Turn the ignition key back to center position.

### LOAD SCRUB BRUSH/PAD

Perform the following steps to load a scrub brush or pad:

1. Turn the ignition key to the right (clockwise) to turn on the RoboScrub 20.
2. Press the one-touch button to raise the scrub deck, if necessary.
3. Position the scrub brush or pad under the scrub deck.
4. Press the one-touch button to lower the scrub deck.
5. Once the scrub deck is completely lowered into position, lightly tap the accelerator pedal.
  - a. The scrub brush or pad will automatically load and lock into position.

# ROBOSCRUB 20 SETUP

## SQUEEGEE ASSEMBLY

The Minuteman® RoboScrub 20, powered by BrainOS, is equipped with a squeegee assembly that houses the squeegee blade. Familiarize yourself with all aspects of the squeegee assembly:

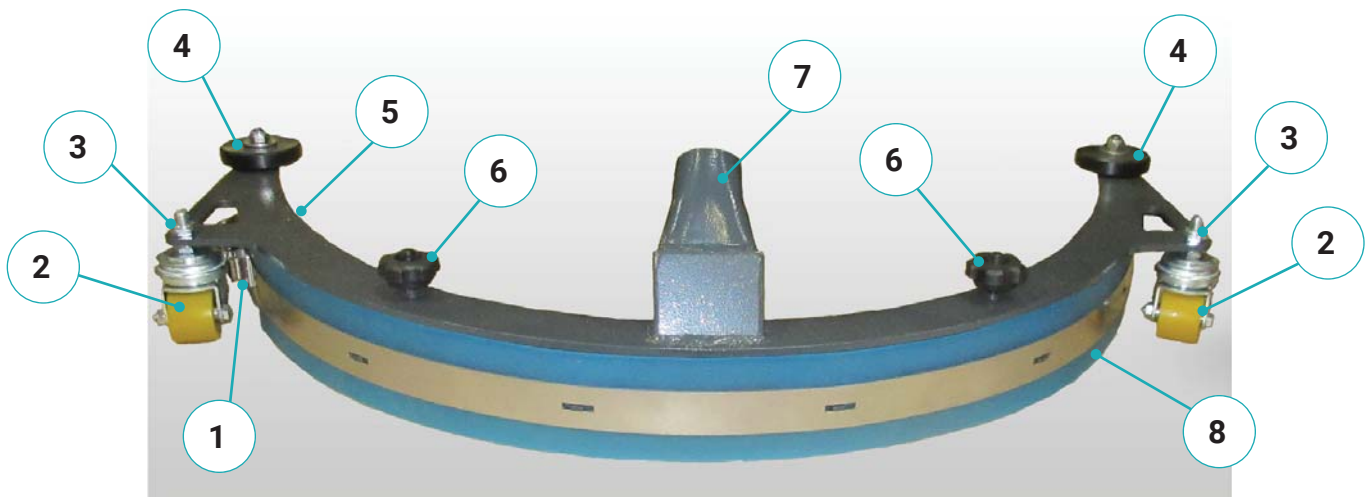

1. Outside Blade Fastening Latch
2. Caster Wheel
3. Nut for Squeegee Height Adjustment
4. Roller

5. Inside Blade Fastening Latch
6. 3-Sided Knob
7. Vacuum Connector
8. Squeegee Blade



# ROBOSCRUB 20 SETUP

## INSTALL AND ADJUST SQUEEGEE

The Minuteman® RoboScrub 20, powered by BrainOS, is typically shipped with the squeegee assembly attached.

### INSTALL/REPLACE SQUEEGEE BLADE

If necessary, perform the following steps to install or replace a squeegee blade into the squeegee assembly:

1. Remove the squeegee assembly by pulling off the vacuum suction hose from the squeegee's vacuum connector.
2. Loosen both 3-sided knobs on the top of the assembly.
3. Remove the lower half of the squeegee assembly.
4. Unlock the inside and outside blade fastening latches of the squeegee blade.
5. Remove the squeegee blade, if present.
6. Insert the new squeegee blade.
7. Return and lock the inside and outside blade fastening latches.
8. Re-affix the lower half of the squeegee assembly to the upper half by tightening both 3-sided knobs on the top of the assembly.
9. Place the squeegee assembly underneath the RoboScrub 20.
10. Reattach the squeegee vacuum connector on the squeegee assembly to the vacuum suction hose underneath the RoboScrub 20.

### ADJUST SQUEEGEE HEIGHT

The height of the squeegee is a direct result of the clearance between the caster wheels and the floor. If streaks are present, this clearance must be adjusted. To adjust the height of the squeegee, perform the following steps:

1. Locate the nut above the bracket that holds the caster wheel.
2. Adjust to the desired height by tightening or loosening this nut on both sides of the squeegee assembly.
  - a. The bottom of the squeegee blade should flare out slightly when the machine is moving forward.

# BEFORE USE

## PRE-OPERATION CHECKS

The RoboScrub 20 is capable of both manual and robotic operation, thanks to BrainOS technology. A subscription to Brain Corp's Autonomy Services is required to use the RoboScrub 20's robotic functions. Robotic mode means that the RoboScrub 20 performs floor cleaning without direct, real-time operator control, which allows janitorial staff to focus on other tasks.

**NOTE:** THE ROBOSCRUB 20 IS A HARD SURFACE FLOOR SCRUBBER ONLY, WITH NO SWEEP FUNCTIONALITY.

Before using the RoboScrub 20, always perform the following checks to ensure proper operation:

- Clear all obstacles from the areas to be cleaned to ensure maximum floor coverage.
- Be sure you understand the functions of all components and controls.
- Check the horn, warning light, and front and rear signal lights to ensure proper operation.
- Check the RoboScrub 20 for fluid leaks.
- Check the tank cover seal under the operator seat or damage and excessive wear.
- Drain and clean the recovery tank, if necessary.
- Clean and rinse the recovery tank screened float, if necessary.
- Drain and clean the solution tank, if necessary.
- Clean the solution fill filter, if necessary.
- Check the vacuum hose for debris or blockage; flush out any obstacles.
- Check the squeegee blade for damage, excessive wear, and deflection. Rotate or replace as needed.
- Check that the scrub brush/pad is properly installed and is clean of restricting debris, such as string, banding, plastic wrap, etc.
- Make sure the batteries are fully charged and free of damage.
- Check the brakes and steering to ensure proper operation.
- Check that all cameras and LIDARs are clean and free of dust, dirt, and smudges. Clean with the provided microfiber cloth, as needed.
- Using appropriate personal protective equipment, fill the solution tank with a pre-mixed solution of an approved cleaning chemical and clean water. Use the solution tank site gauge to guide while pouring. Do not overfill.
- Check that the audible cues can be heard for the RoboScrub 20.
- Place proper floor cleaning signage in areas where the RoboScrub 20 is operating in accordance with standard floor cleaning practices.



**WARNING:** DO NOT PUT ANY FLAMMABLE MATERIALS INTO THE SOLUTION BOTTLE OR CLEAN WATER TANK. THIS CAN CAUSE AN EXPLOSION OR FIRE.

# MANUAL OPERATION

## MANUAL OPERATION

Before turning on the RoboScrub 20, make sure it is fully charged and free of damage. Perform the following steps to use the Minuteman® RoboScrub 20 manually:

1. Fill the solution tank via the solution fill port located on the top left corner of the back of the RoboScrub 20.



2. Ensure the operator seat is securely lowered with the two contact switches connected.

3. Sit on the operator seat, insert the ignition key and turn to the right (clockwise) to start the RoboScrub 20. Wait for the User Interface (UI) Touch Screen to display options to Run Route, Teach Route, and Settings.



4. Press the up or down direction button to determine whether you will be driving forward or backward.

5. Select the desired solution flow control setting.



6. Press the one-touch button to engage the cleaning components (scrub brush and squeegee are lowered, and vacuum turns on). When cleaning is complete, press the one-touch button again to disengage the cleaning components.

7. Press the accelerator pedal to drive the RoboScrub 20 along the desired cleaning route. You can adjust your speed via the force applied to the pedal – light is slow, heavy is fast. Remove pressure completely from the accelerator pedal to stop.



# ROBOTIC OPERATION

## ROBOTIC MODE OPERATION

The RoboScrub 20 is equipped with BrainOS technology that offers a robotic mode feature. Robotic mode provides the ability for the machine to perform floor cleaning by following one of the saved navigation routes without direct, real-time operator control. The machine can only operate in robotic mode in areas where cleaning routes have been taught and saved. BrainOS software is accessible via the UI touchscreen, and provides access to teach a new cleaning route, run an existing route robotically, access triggered alert messages, and more. The UI touchscreen also provides constant visibility to current battery life, the number of hours the machine has operated, and ROC connection status.

## ESTABLISH HOME MARKERS



Home Markers must be permanently installed before you can begin using the machine in robotic mode. A Home Marker is a unique scan code identifier that the machine scans to determine its current physical location, as well as any routes that have been saved to that specific Home Marker. The machine is designed to work with up to 10 Home Marker. Each Home Marker can store up to 6 routes for a total of 60 routes.

Home Markers are used to establish the start and end point of a cleaning route. The number of Home Markers needed may vary, depending on the size of the space where the machine will be operating in robotic mode.

- Multiple Home Markers may be necessary for large or unusually mapped areas where more than 6 cleaning routes are needed.
- Establish a unique Home Marker for each floor of a multi-level building.
- Install Home Markers in a permanent location on an open wall or column near commonly cleaned areas that do not change from day-to-day. If the Home Marker is moved even slightly, the route may not be performed correctly.
- Install Home Markers at a height of 40 in (100 cm) from the ground.
- Install Home Markers so that the machine can easily scan with its right side camera at a distance of no less than 24 in (61 cm).
- Affix the Home Marker securely to the wall.
- The entire Home Marker must be clearly visible, not hidden behind furniture or shelving.
- Do not install Home Markers near stairways, fire exits, or fire, first aid, or emergency equipment.
- Do not photocopy, laminate, or place Home Markers in a glossy sleeve or cover, as this may prevent the machine from being able to scan.
- If a Home Marker is lost or damaged, contact customer service for a replacement.

## REGION

The UI (User Interface) touchscreen can be set to display in a variety of languages. English is the default language. Perform the following steps to set the UI touchscreen to display in a different language:

1. Insert the ignition key and turn to the right (clockwise) to turn on the machine. Wait for the UI touchscreen to initialize.
2. Enter the 4-digit Security PIN via the UI touchscreen. Upon successful PIN entry, the UI touchscreen displays the Main Menu.
3. Select **SETTINGS** from the Main Menu.



4. Select **REGION**.

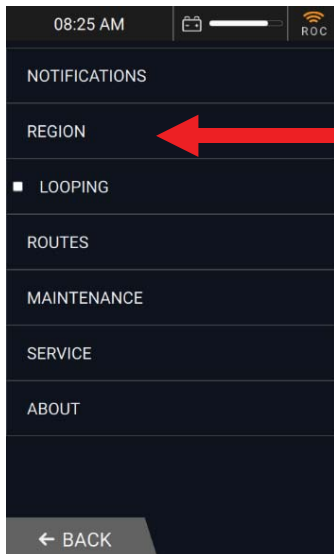

5. Select **CHANGE LANGUAGE**.

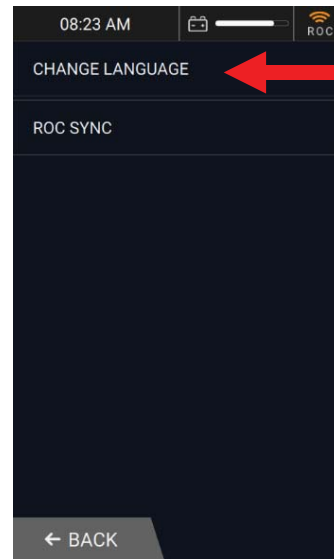

6. Select the desired language.

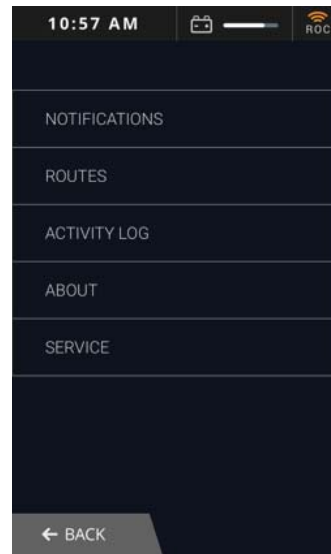

7. Select **BACK** twice to return to the Main Menu, which will display in the selected language.

# ROBOTIC OPERATION

## ROC: ROBOT OPERATIONS CENTER

BrainOS software provides access to Brain Corp's Robot Operations Center, also known as the ROC. The ROC is a cloud-based robot operations center, managed by Brain Corp technicians, that enhances the machine's abilities by providing monitoring and analytics. The ROC is connected via a 4G LTE modem and does not require user interaction to connect. New versions of BrainOS software are automatically uploaded to the machine without disrupting service or operator interaction.

There is a ROC indicator on the UI touchscreen's status bar. When the indicator is orange, the machine is successfully connected to the ROC. If the indicator is gray, the ROC is not connected and cannot be paired with a cell phone.

## PAIR A PHONE TO THE ROC

Before running a cleaning route in robotic mode, it is recommended that the operator pair their cell phone to the ROC. When a cell phone is paired to the ROC, the ROC will send SMS or MMS messages to the phone whenever the machine encounters an alert and/or when the route is complete.

To ensure only the onsite operator receives alerts from the ROC, only one phone number at a time can be paired to the ROC to receive status alerts. A paired phone number is automatically discarded when the machine is turned off or a new phone is paired.

Perform the following steps to pair a cell phone to the ROC:

1. Insert the ignition key and turn to the right (clockwise) to turn on the machine. Wait for the UI touchscreen to initialize.
2. Enter the 4-digit PIN via the UI touchscreen. Upon successful PIN entry, the UI touchscreen displays the Main Menu.
3. Select **SETTINGS** on the Main Menu.
4. Select **NOTIFICATIONS**.
5. Follow the instructions on the UI touchscreen to pair the cell phone to the ROC.
6. Pairing is successful when the cell phone receives a confirmation text message.

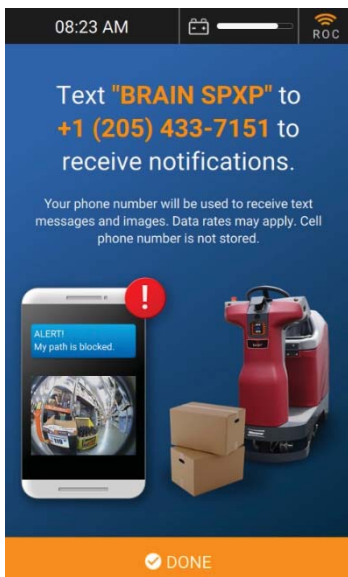
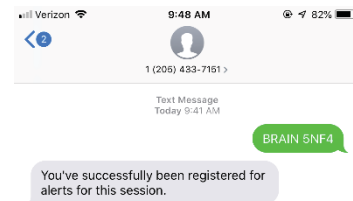

## TEACH A ROBOTIC ROUTE

The RoboScrub 20 must be taught one or more cleaning navigation routes before it can run robotically. Perform the following steps to teach a new route:

1. Sit in the operator seat, insert the ignition key and turn to the right (clockwise) to turn on the machine. Wait for the UI touchscreen to initialize.
2. Enter the 4-digit Security PIN using the UI touchscreen. Upon successful PIN entry, the UI touchscreen displays the Main Menu.
3. Select **TEACH ROUTE**.



4. The UI touchscreen displays **Drive to scan my home location**. Drive to the desired Home Marker, positioning the machine so the right-side camera is no less than 24 in (61 cm) away. The machine will automatically scan the Home Location Code.



**NOTE: IF THE MACHINE IS UNABLE TO SCAN THE HOME LOCATION CODE, THE UI TOUCHSCREEN WILL DISPLAY AN ERROR MESSAGE WITH SUGGESTIONS ON HOW TO RESOLVE.**

5. A **Success! Choose a box to save your route to.** message briefly appears on the UI touchscreen after the machine successfully scans the Home Location Code, followed by a list of all existing and available routes for the scanned Home Location Code.



**NOTE: IF NO ROUTES ARE AVAILABLE, AN EXISTING ROUTE MUST BE DELETED IN ORDER TO TEACH A NEW ROUTE.**



# ROBOTIC OPERATION

6. Select one of the available routes. The UI touchscreen states **Ready. I will learn as you drive.**

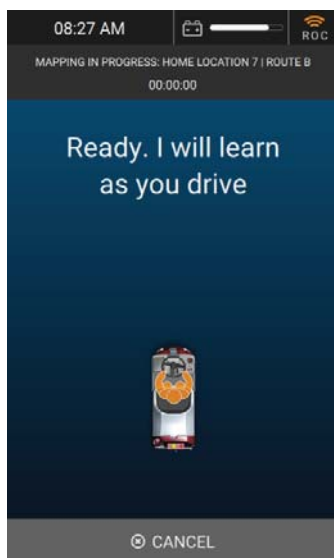

7. Press the One-Touch button to engage the cleaning components; the scrub brush/pad and squeegee are lowered, and the vacuum turns on. The One-Touch button's light will illuminate.



**NOTE:** IF THE ONE-TOUCH BUTTON OR VACUUM BUTTON IS NOT PRESSED, THE ROUTE WILL BE SAVED WITH NO CLEANING COMPONENTS ENGAGED.

8. Press the accelerator pedal and drive the machine through the entire cleaning route to be saved. As soon as driving begins, the UI touchscreen states **Learning...** along with the amount of time spent on the route so far.

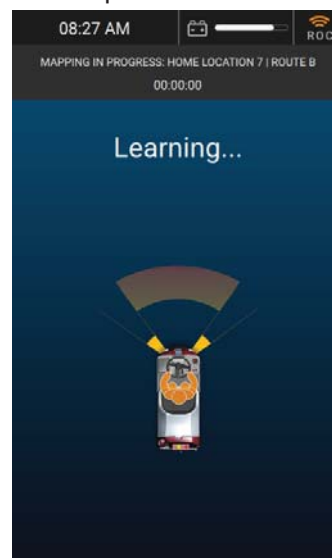

**NOTE:** WHEN TEACHING A NEW ROUTE WITH A NON-SCRUBBABLE AREA, PRESS THE ONE-TOUCH BUTTON TO RAISE THE SCRUB BRUSH AND SQUEEGEE APPROXIMATELY 10 FT (120 IN OR 305 CM) PRIOR TO REACHING THE AREA. DRIVE PAST THE NON-SCRUBBABLE AREA AND PRESS THE ONE-TOUCH BUTTON AGAIN TO LOWER THE SCRUB BRUSH AND SQUEEGEE. THE BRAINOS NAVIGATION SOFTWARE WILL REMEMBER WHERE IN THE ROUTE THE CLEANING SYSTEMS WERE LIFTED AND LOWERED WHEN OPERATING IN ROBOTIC MODE.



# ROBOTIC OPERATION

9. Once driving stops, the UI touchscreen states **Learning Paused. Drive to resume.** with options to **SAVE** or **CANCEL**. Select **SAVE** to save the new route.

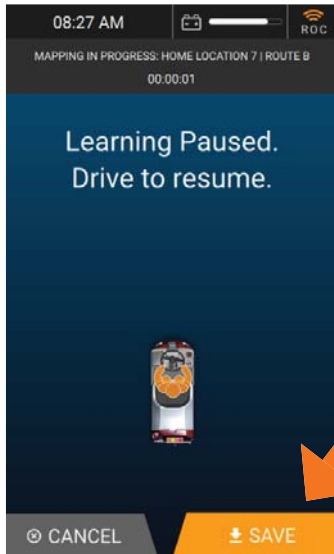

10. The machine will scan the Home Marker a second time as the end point of the cleaning route. If the machine does not see the Home Marker from its right-side camera, the UI touchscreen states **Drive to scan my home location.**

**NOTE:** A NEW CLEANING ROUTE CANNOT BE SAVED UNTIL THE MACHINE SCANS THE SAME HOME LOCATION CODE IN THE SAME PHYSICAL LOCATION A SECOND TIME.

11. The UI touchscreen displays **Saving...** When the route is successfully saved, the UI touchscreen briefly displays **Success! Route saved.** and then returns to the Main Menu. The new cleaning route is saved and is now available to run in robotic mode.

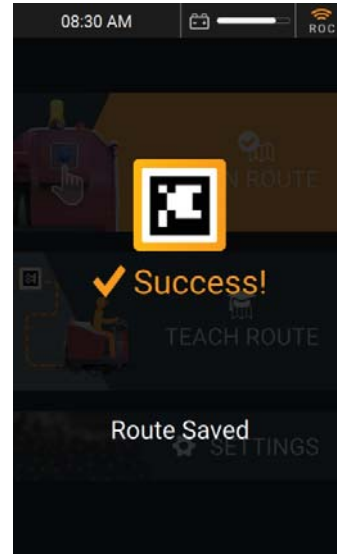

**NOTE:** SOLUTION FLOW LEVELS ARE NOT SAVED AS PART OF THE ROBOTIC ROUTE, AS CLEANING NEEDS MAY VARY FROM DAY-TO-DAY.

# ROBOTIC OPERATION

## **BEST PRACTICES WHEN TEACHING A ROUTE**

- Drive in a straight path as much as possible.
- Don't teach a route with an incline or decline.
- Don't teach routes that include driving into an elevator or automatic doors.
- Avoid sudden turns and/or turning the steering wheel too sharply when driving.
- Maintain a safe distance of approximately 1½ ft (18 in) from the edge of ramps, platforms, cliffs, and glass.
- Avoid U-turns. The RoboScrub 20 requires a width of at least 8½ feet to perform a U-turn. Avoid making U-turns as much as possible.
- Avoid tight spaces. The RoboScrub 20 requires a width of at least 3½ feet when driving a straight line and 4½ feet to make turns around a corner or when turning into an aisle.
- Teach routes when the area is mostly clear of obstacles and people that may block the RoboScrub 20's path.
- If a route is taught in an area with obstructions that are later removed, the RoboScrub 20 will not clean any areas previously occupied by those obstructions.
- Once a route is taught, test it to ensure the RoboScrub 20 can perform the route in robotic mode successfully. If many assists are triggered during the test run, the route may include maneuvers that are difficult to perform robotically.
- Avoid teaching routes over 45 minutes long. The RoboScrub 20 runs at approximately half speed when operating in robotic mode; therefore, it can take up to 1½ hours to robotically clean a route that only took 45 minutes to run manually.

# ROBOTIC OPERATION

## RUN A ROBOTIC ROUTE

Once one or more cleaning routes have been taught and saved, the machine can be operated in robotic mode. When running a route in robotic mode, pairing a cell phone can be a valuable tool. (See [Pair a Phone to the ROC](#) for details.)

1. Insert the ignition key and turn to the right (clockwise) to turn on the machine.
2. Wait for the UI touchscreen to initialize to enter the 4-digit Security PIN.
3. Select **RUN ROUTE** from the Main Menu.
6. Select the cleaning route to run in robotic mode.



4. Drive to the desired Home Marker, positioning the machine so that the right-side camera scans the Home Marker. The machine automatically begins scanning, as displayed on the UI touchscreen.
5. A **Success! Select a route to clean** message is briefly displayed, followed by a list of all existing routes for the scanned Home Marker.



7. If necessary, adjust the solution flow setting for today's cleaning needs.
8. Step off the RoboScrub 20, and either remove the operator seat cushion or tuck the top half under the bottom half to display the yellow **STAY CLEAR** warning. This alerts passersby of robotic operation.



# ROBOTIC OPERATION

9. Press the Start/Pause button on the back of the machine to start the robotic route. The yellow warning light flashes and the horn sounds to signal that robotic cleaning is starting.

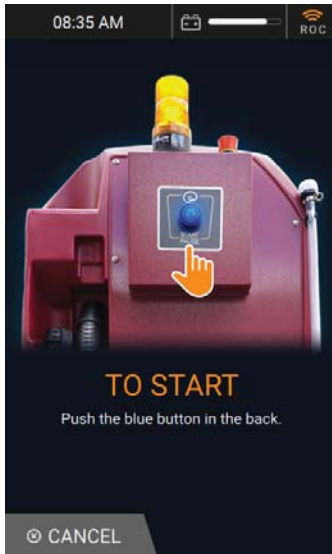

10. As the machine begins robotic operation, the UI touchscreen states Cleaning in Progress, along with the machine's current location on the cleaning route, amount of time spent on the route, and the total amount of time the route is projected to take in robotic mode.

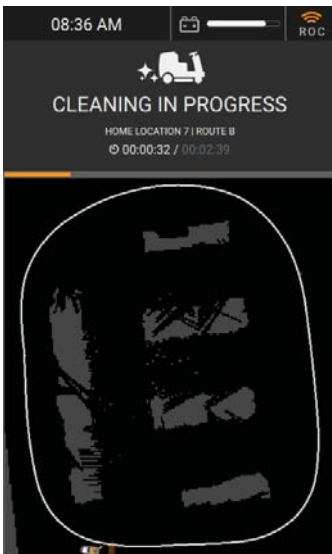

11. Observe scrubbing performance to ensure that all components are functioning properly.

12. If any scrubbing functions need adjustment, press the Start/Pause button on the back of the machine to pause the robotic route. The UI touchscreen states Cleaning Paused: Press the blue button to resume cleaning!

13. Make the necessary adjustments to the solution flow and/or squeegee.

14. Press the Start/Pause button to resume the route in robotic mode.

**NOTE:** IF AN ALERT IS TRIGGERED DURING THE ROBOTIC ROUTE, THE MACHINE AUTOMATICALLY PAUSES. THE UI TOUCHSCREEN DISPLAYS THE ALERT ALONG WITH STEPS TO RESOLVE. IF A PHONE IS PAIRED TO THE ROC, THE ROC SENDS A TEXT MESSAGE OF THE ALERT TO THE PHONE.

15. When the robotic route is complete, the UI touchscreen displays Cleaning Complete, as well as route information, length of time spent on the route, and a map of the route that shows areas cleaned. If a phone is paired to the ROC, the ROC sends a Cleaning Complete text message.

16. Select DONE to return to the Main Menu.



## FOR SAFETY

- The steering wheel may rapidly and unexpectedly move while operating in robotic mode, which could cause physical injuries. Do not sit on the operator seat, hold the steering wheel, or put your hand or arm through the holes of the steering wheel while the machine is operating in robotic mode.
- The operator seat and steering wheel have joy-ride sensors. If a person attempts to sit on the seat or hold the steering wheel when operating in robotic mode, the machine will automatically stop and trigger an alert.



If the machine repeatedly triggers an alert in the same place on a cleaning route, even when there are no obstructions, there could be an environmental factor such as a reflection causing the machine to sense an obstruction in the cleaning path. For help resolving the issue, contact customer service and provide the Home Location Code number, route letter, area of concern, and pictures of what the machine sees (if possible). Customer service may be able to remotely adjust the route to improve performance.

# ROBOTIC OPERATION

## **BEST PRACTICES WHEN RUNNING A ROUTE**

- Remove any rugs, fallen items, or large debris from the floor.
- Sweep the floor.
- Pair your phone to the ROC to receive text messages whenever the RoboScrub 20 encounters an alert and/or when the robotic route is complete.
- Run routes when the area is most free of people and other obstructions.
- Monitor the RoboScrub 20 squeegee during the first 30 seconds of running the route to ensure they're properly adjusted.

## ALERTS DURING OPERATION

The UI touchscreen displays a message when an alert occurs. Alerts can occur during manual or robotic operation. When an alert occurs during robotic operation, the machine is automatically paused. The UI touchscreen displays details of the triggered alert, along with steps to resolve the issue. When a phone is paired to the ROC to receive notifications, a text message of the alert is sent to the paired phone. If necessary, the machine can be manually driven when an alert has been triggered, but all scrubbing functions are disabled.

The following table provides a list of possible alerts with steps to resolve.

ALERT	CAUSE	RESOLUTION
ROBOT IS OFF PATH	Machine is off robotic	<ol style="list-style-type: none"> <li>1. Follow the blue arrow and drive to the red path.</li> <li>2. When correct, the path will turn white.</li> <li>3. Press rear BLUE button to start.</li> </ol>
IMPACT DETECTED	Machine bumped obstacle on cleaning route	<ol style="list-style-type: none"> <li>1. Make sure the robot's path is clear or drive past any obstacles.</li> <li>2. Inspect the robot.</li> <li>3. If everything is clear, press rear BLUE button to start.</li> </ol>
MACHINE ERROR	Steering wheel obstruction	<ol style="list-style-type: none"> <li>1. Make sure that the steering wheel is free and clear.</li> <li>2. Press the BLUE button in the back to resume.</li> </ol>
UNKNOWN ERROR	Error(s) of unknown origin	<ol style="list-style-type: none"> <li>1. Turn off and inspect machine.</li> <li>2. Reboot and attempt to operate.</li> <li>3. If issue persists, contact customer service.</li> </ol>
203 TRACTION MOTOR ERROR	Acceleration issues	<ol style="list-style-type: none"> <li>1. Power off robot.</li> <li>2. Disconnect then reconnect the battery.</li> <li>3. Power the robot back on.</li> <li>4. If issue persists, contact customer service.</li> </ol>
204 BRUSH ERROR	Debris caught in brush or brush is damaged	<ol style="list-style-type: none"> <li>1. Inspect brush/pad for damage or debris. Adjust or replace as needed.</li> <li>2. If there are no issues, press the BLUE button on the back to resume.</li> <li>3. If issue persists, contact customer service.</li> </ol>
205 VACUUM ERROR	Vacuum hose obstructed or damaged	<ol style="list-style-type: none"> <li>1. Inspect vacuum and hose for damage or debris.</li> <li>2. If the hose is clear, press the BLUE button to resume. If the hose is broken, call customer service.</li> </ol>

# ROBOTIC OPERATION

ALERT	CAUSE	RESOLUTION
206 SQUEEGEE ERROR	Squeegee is obstructed, damaged, or missing	<ol style="list-style-type: none"> <li>1. Inspect squeegee for damage or debris. Adjust or replace as needed.</li> <li>2. If there are no issues, press the BLUE button in the back to resume.</li> <li>3. If the issue persists, contact customer service.</li> </ol>
207 SCRUB DECK ERROR	Scrub deck obstruction is preventing raising/ lowering	<ol style="list-style-type: none"> <li>1. Turn off and inspect machine.</li> <li>2. If there are no issues, press the BLUE button in the back to resume.</li> <li>3. For damage or persistent problems, contact customer service.</li> </ol>
208 NO BRUSH ERROR	Brush missing or improperly installed	<ol style="list-style-type: none"> <li>1. Make sure brush or pad is properly installed.</li> <li>2. If there are no issues, press the BLUE button in the back to resume.</li> <li>3. If issue persists, contact customer service.</li> </ol>
BRAKE ERROR	Electronic/mechanical throttle error or issue	Contact Customer Service Immediately.
THROTTLE ERROR	Electronic/mechanical throttle error or issue	Contact Customer Service Immediately.



## EMERGENCY STOP

The RoboScrub 20 is equipped with two Emergency Stop (aka E-Stop) buttons, one to the right of the steering wheel and one on the rear of the machine. If there is an emergency and the RoboScrub 20 must be immediately stopped, press one of these red Emergency Stop buttons.

**NOTE:** THE ROBOSCRUB 20 MAY RELEASE ANY FLUIDS THAT HAVE NOT YET REACHED THE RECOVERY TANK. MAKE SURE TO MOP UP ANY STANDING FLUIDS TO AVOID A SLIPPING OR FALLING HAZARD.

If the Emergency Stop button was pressed in error or the emergency has been resolved, perform the following steps to resume the robotic route:

1. Per UI touchscreen instructions, inspect the environment and the machine, and clean up any standing fluids.
3. Select **CONFIRM** to confirm that any environmental or machine issues have been resolved.
4. Press the Start/Pause button on the rear of the machine to resume the robotic route.



2. Release the engaged Emergency Stop button by twisting it to the right (clockwise).

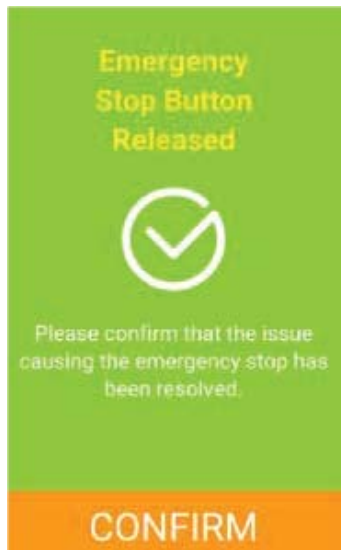

# ROBOTIC OPERATION

## DELETE A ROUTE

Perform the following steps to delete an existing route:

1. Insert the ignition key and turn to the right (clockwise) to turn on the machine.
2. Wait for the UI touchscreen to initialize to enter the 4-digit Security PIN.
3. Select **SETTINGS** from the Main Menu.



4. Select **ROUTES**.

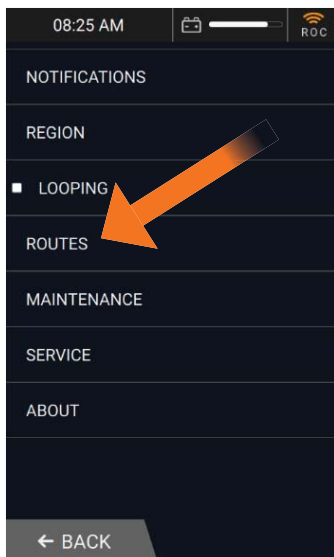

5. Select the desired Home Marker to view existing routes available for deletion.



6. All existing routes for the selected Home Marker are displayed. Select the route to be deleted.



# ROBOTIC OPERATION

7. Select **DELETE ROUTE** to permanently delete the selected route from the machine.

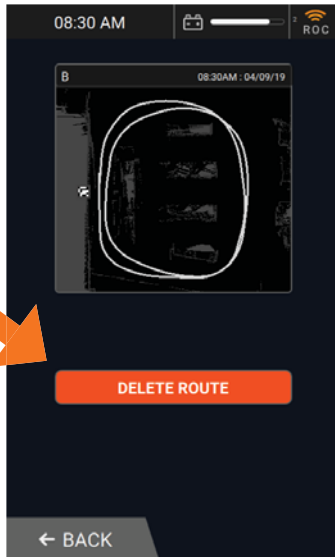

**NOTE:** SELECT **BACK** TO RETURN TO THE LIST OF EXISTING ROUTES.

8. To confirm deletion, select **YES DELETE** to permanently delete the selected route.



9. All existing routes for the Home Marker are displayed. The deleted route no longer appears on the screen.



10. When finished, select **BACK** three times to return to the Main Menu.

## AFTER USE DAILY TASKS

When you are finished using your RoboScrub 20, perform the following recommended daily tasks to clean and store the RoboScrub 20.

### DRAIN AND CLEAN TANKS, HOSES, AND FILTERS

1. Disengage all cleaning components by pressing the one-touch button, if needed. Doing so will raise the scrub brush and squeegee, as well as turn off the vacuum motor.
2. Using appropriate personal protective equipment, drain the recovery tank using the recovery tank drain hose located on the rear left of the RoboScrub 20.
3. Using appropriate personal protective equipment, clean out the recovery tank and its internal screened float of any remaining debris by flushing with water and/or wiping clean.
4. Using appropriate personal protective equipment, drain the solution tank using the solution tank site gauge/drain hose located on the rear right of the RoboScrub 20.
5. Rinse the solution tank with clean water to prevent chemical buildup and clogging of water lines.
6. Remove the solution fill filter from the solution fill port on the rear, top left side of the RoboScrub 20 and rinse with clean water.

### CLEAN SCRUB BRUSH/PAD

1. Unload and remove the scrub brush or pad. See INSTALL SCRUB BRUSH/PAD on page 21 for details.
2. Remove any wire, string, or twine wrapped around the brush/pad.
3. Rinse with warm water.
4. Hang to dry.

### CLEAN SQUEEGEE

Check the squeegee daily, and clean as necessary. Perform the following steps to clean:

1. Remove the squeegee: See INSTALL AND ADJUST SQUEEGEE on page 22 for details.
2. Rinse with warm water.
3. Wipe clean.
4. Reinstall.

## CLEAN IN-LINE SOLUTION FILTER

The solution solenoid, which shuts off solution flow, is protected from debris by the in-line filter assembly located on the under-carriage of the RoboScrub 20 on the left-hand side, just under the solution tank. It is important to check and clean the screened washer inside the assembly regularly to ensure proper solution flow. Perform these steps to access and clean the screened washer:

1. Lift the scrub deck, if necessary.
2. On the under-carriage of the RoboScrub 20, pull the blue shut-off handle (shown below) to the closed position.
3. Unscrew the screen assembly (shown below).
4. Remove the screen and rinse.
5. Once clean, reinsert the screen.
6. Screw the assembly together, tightening by hand.
  - a. Over-tightening with tools may damage the plastic threads.

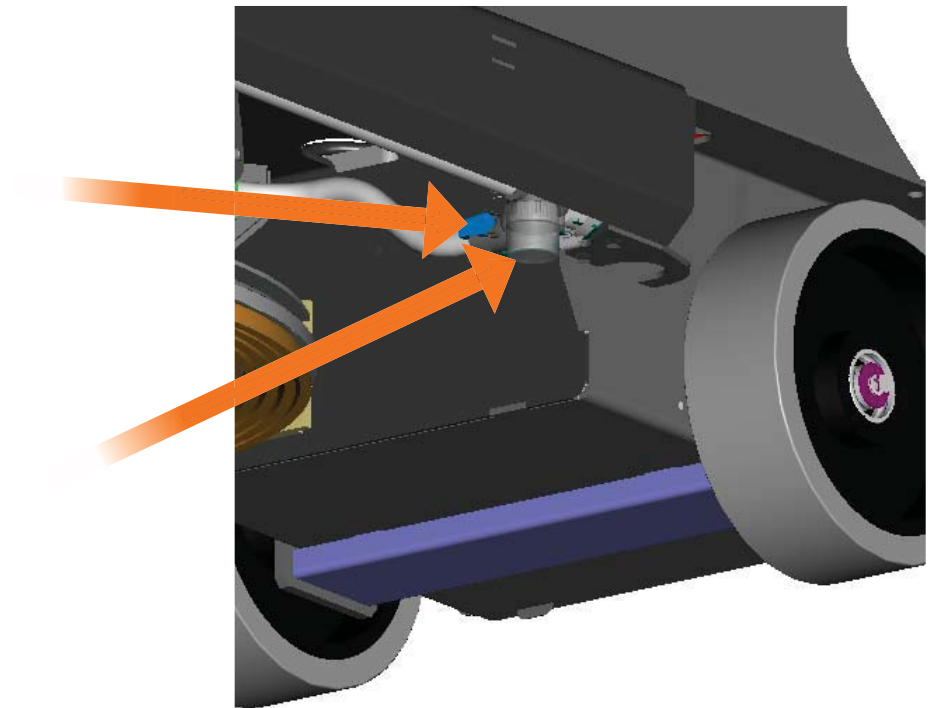

# AFTER USE

## PARK AND POWER DOWN

When not in use, the RoboScrub 20 should be stored in a designated parking station. Turning off and securing the RoboScrub 20 is vital. Turn the ignition key to the left (counter-clockwise) to turn off the RoboScrub 20. Remove the key to prevent unauthorized use.

**NOTE: ALWAYS PARK THE ROBOSCRUB 20 AWAY FROM STAIRWAYS, FIRE DOORS, AND FIRE EQUIPMENT.**

## ROBOSCRUB 20 STORAGE

1. Always store in a designated parking station that is secured from public access.
2. Always store indoors.
3. Always store in a dry area.
4. Always store in its upright position.
5. Always store with the pad driver/brush raised off the floor.
6. Always store with the rear and side squeegee assemblies raised off the floor.
7. Drain all fluids from the clean water tank, recovery tank, and solution bottle; especially if storing in an area which may reach freezing temperatures. Any damage caused by freezing temperatures will not be covered by the warranty.



# BATTERY CHARGING

## BATTERY CHARGING

The RoboScrub 20's battery is designed to last up to 3 – 3.5 hours on the lowest solution flow control setting when using the recommended AGM batteries. Charge the batteries when the RoboScrub 20 is not in operation.

Dispose of components such as batteries, hazardous fluids such as antifreeze, and oil in an environmentally safe way according to local waste disposal regulations.

**NOTE: THE MACHINE CANNOT OPERATE WHEN CHARGING.**

Perform the following steps to charge the batteries:

1. Place the RoboScrub 20 in a well-ventilated area.
2. Turn off the RoboScrub 20.
3. Remove the battery compartment cover.
4. Unwind the power supply cord and insert into a properly grounded receptacle.
5. The battery charge Indicator will turn red to indicate charging. Once charging is complete, this indicator turns green.
6. When charging is complete, disconnect the power supply cord and wind up to the right of the batteries accordingly.
7. Place the battery compartment cover back into position.





# BRAKE RELEASE

## BRAKE RELEASE PROCEDURE

The RoboScrub 20 is stopped via an electromagnetic brake, located on the front drive wheel assembly. When the accelerator pedal is pressed the electromagnetic brake releases, which allows the RoboScrub 20 to move forward or backward. When pressure is removed from the accelerator pedal, the electromagnetic brake presses against the front drive wheel to stop the RoboScrub 20.

If the RoboScrub 20 is inoperable or immobile, it can be manually moved by releasing the electromagnetic brake by performing the following steps:

1. Turn the RoboScrub 20 off using the ignition key.
2. Locate the electromagnetic brake on the front drive wheel assembly.
3. Place a small, flathead screwdriver between the wheel and the brake release lever. This will bypass the electromagnetic brake.
4. Slowly push the RoboScrub 20 to a safe location where it can remain until a service technician arrives to perform repairs.
5. Once you have moved the RoboScrub 20 to a safe place, remove the screwdriver from the front drive wheel assembly to activate the electromagnetic brake.



## FOR SAFETY

- DO NOT PERFORM THE BRAKE RELEASE PROCEDURE ON AN INCLINE/DECLINE. IT IS UNSAFE TO PUSH THE ROBOSCRUB 20 ON AN INCLINE/DECLINE, AS IT'S DIFFICULT TO STOP.
- CHECK FOR AND CLEAN UP ANY RESIDUAL WATER OR LIQUIDS ON THE FLOOR BEFORE PERFORMING THE BRAKE RELEASE PROCEDURE.
  - TWO PEOPLE ARE REQUIRED TO MOVE THE ROBOSCRUB 20 ONCE THE BRAKE IS RELEASED, ONE PERSON TO STEER AND ONE TO PUSH.
- THE BRAKE RELEASE PROCEDURE REQUIRES YOU TO ACCESS THE UNDERSIDE OF THE ROBOSCRUB 20 AND PHYSICALLY PUSH. USE PRECAUTION WHEN PERFORMING THIS TASK TO AVOID INJURY.
- DO NOT RUSH WHEN PUSHING THE ROBOSCRUB 20. THE FASTER YOU TRY TO PUSH, THE SLOWER THE MACHINE WILL MOVE.
  - PUSH SLOWLY AND BE CAUTIOUS NOT TO SLIP ON WET FLOORS.
- DO NOT ATTEMPT TO PERFORM THIS BRAKE RELEASE PROCEDURE IF YOU HAVE ANY HEALTH ISSUES OR PHYSICAL LIMITATIONS.

## DAILY MAINTENANCE

Perform the following maintenance tasks daily to keep the RoboScrub 20 operating at peak performance.

### FOR SAFETY

TURN OFF THE ROBOSCRUB 20 AND DISCONNECT THE BATTERIES BEFORE PERFORMING ANY MAINTENANCE!

REPAIRS ARE TO BE COMPLETED BY AUTHORIZED TECHNICIANS ONLY.

## DRAIN AND CLEAN TANKS, HOSES, AND FILTERS

1. Disengage all cleaning components by pressing the one-touch button, if needed. Doing so will raise the scrub brush and squeegee, as well as turn off the vacuum motor.
2. Drain the recovery tank using the recovery tank drain hose located on the rear left of the RoboScrub 20.
3. Using appropriate personal protective equipment, clean out the recovery tank and its internal screened float of any remaining debris by flushing with water and/or wiping clean.
4. Using appropriate personal protective equipment, drain the solution tank using the solution tank site gauge/drain hose located on the rear right of the RoboScrub 20.
5. Rinse the solution tank with clean water to prevent chemical buildup and clogging of water lines.
6. Remove the solution fill filter from the solution fill port on the rear, top left side of the RoboScrub 20 and rinse with clean water.

### FOR SAFETY

USE APPROPRIATE PROTECTIVE EQUIPMENT WHEN HANDLING CLEANING CHEMICALS.

## CLEAN SENSORS

Clean all of the RoboScrub 20's sensors using the provided microfiber cloth.

**NOTE: DO NOT SPRAY ANY KIND OF LIQUID ON THE SENSORS OR THE MICROFIBER CLOTH. ONLY USE A DRY MICROFIBER CLOTH.**

# MAINTENANCE & SAFETY

## CLEAN SCRUB BRUSH/PAD

Check the scrub brush/pad daily, and clean as necessary. Perform the following steps to clean:

1. Unload and remove the scrub brush or pad. See INSTALL SCRUB BRUSH/PAD on page 21 for details.
2. Remove any wire, string, or twine wrapped around the brush/pad.
3. Rinse with warm water.
4. Hang to dry.

## CLEAN SQUEEGEE

Check the squeegee daily, and clean as necessary. Perform the following steps to clean:

1. Remove the squeegee. See INSTALL AND ADJUST SQUEEGEE on page 23 for details.
2. Rinse with warm water.
3. Wipe clean.
4. Reinstall.

## PARK AND STORE RoboScrub 20

Park the RoboScrub 20 in a designated parking station, turn it off, and remove the ignition key to prevent unauthorized use. Make sure the designated parking station meets the following criteria:

1. Indoors.
2. Well-ventilated dry environment.
3. Away from stairways, fire doors, and fire equipment.

## CHARGE BATTERIES

Charge the batteries when the RoboScrub 20 is not in operation by performing these steps:

1. Place the RoboScrub 20 in a well-ventilated area.
2. Turn off the RoboScrub 20.
3. Remove the battery compartment cover.
4. Unwind the power supply cord and insert into a properly grounded receptacle.
5. The battery charge indicator will turn red to indicate charging. Once charging is complete, this indicator turns green.
6. When charging is complete, disconnect the power supply cord and wind up to the right of the batteries accordingly.
7. Place the battery compartment cover back into position.

# MAINTENANCE & SAFETY

## WEEKLY MAINTENANCE

Perform the following maintenance tasks on a weekly basis:

1. Check the scrub deck skirt and clean as needed.
2. Check the solution fill filter and clean as needed.
3. Check the squeegee blade for signs of wear.
  - a. The squeegee blade can be reused by flipping them.
  - b. A squeegee blade can be flipped up to 4 times. Replace after the 4th time.

## MONTHLY MAINTENANCE

Perform the following maintenance tasks on a monthly basis:

1. Lubricate grease fittings.

## YEARLY MAINTENANCE

Perform the following maintenance tasks on a yearly basis:

1. Check vacuum motor carbon brushes once a year or every 300 operating hours, whichever comes first.
2. Check brush motor and transaxle motor carbon brushes once a year or every 500 hours, whichever comes first.

## PERIODIC MAINTENANCE

Inspect all mechanical functions of the RoboScrub 20 prior to each use, and perform the following tasks as needed:

1. Check all tank cover seals for damage.
2. Drain and clean the recovery tank, if necessary.
3. Check vacuum hose for debris or blockage. Flush the vacuum hose to remove buildup, as necessary.
4. Check the battery connections for wear and loose terminals.
5. Check the scrub brush/pad for damage, wear, and proper installation. Replace if needed.
6. Check squeegee for damage, wear, and proper installation. Replace if needed.
7. Check the brakes and steering for proper operation.
8. Make sure all sensors are clean and unobstructed.

# TROUBLESHOOTING & SUPPORT

## ROBOSCRUB 20 FAQs

### FREQUENTLY ASKED QUESTIONS AND ANSWERS

**Q:** HOW LONG OF A ROUTE CAN I TEACH?

**A:** As a general rule, it's recommended to teach 45 minute routes due to the water tank capacity, environment, and difference in run-time when running in robotic mode. A route that takes 45 minutes to teach can take the RoboScrub 20 about 1½ hours to run in robotic mode.

**Q:** HOW MANY ROUTES CAN I TEACH?

**A:** You can teach up to 6 routes per home location code. 10 home location codes are provided, so you can teach up to 60 routes total.

**Q:** WHAT SHOULD I KEEP IN MIND WHEN TEACHING A ROUTE?

**A:** When teaching a new route, try to make wide graceful turns versus sharp turns or U-turns. Avoid U-turns as much as possible by circling around an aisle or alternating aisles.

**Q:** WHEN THE RoboScrub 20 REACHES A POINT WHERE IT IS SUPPOSED TO TURN (OR TURN AROUND), IT STOPS AND ASKS FOR HELP. IS THERE A MINIMUM SPACE NEEDED TO OPERATE OR TURN AROUND?

**A:** Think of "3½ - 4½ - 8½". When your RoboScrub 20 is on a straight path, it can go through spaces as narrow as 3½ feet wide (between two displays for example). When making a turn or going around a corner, it requires a minimum width of 4½ feet. To make a U-turn, it requires a width of at least 8½ feet.

**Q:** MY RoboScrub 20 GETS STUCK IN THE SAME PLACE EVERY DAY. THERE IS NOTHING THERE, BUT IT ALWAYS STOPS AND ASKS FOR HELP. WHAT'S GOING ON?

**A:** There could be an environmental factor such as a reflection causing the RoboScrub 20 to think something is blocking its path. For safety reasons, it errs on the side of caution. If this is a recurrent issue, contact customer service and provide the home location code number, route letter, area of concern, and pictures of what the RoboScrub 20 sees. In some cases, customer service may be able to remotely adjust the route to improve performance.

**Q:** HOW DO I PAIR MY PHONE?

**A:** On the touch screen, select SETTINGS and then NOTIFICATIONS. Use your phone to text the code to the phone number, as the screen instructs. When successfully paired, you will receive a text message stating that you have been successfully registered.

**Q:** I PAIRED MY PHONE YESTERDAY, BUT TODAY I'M NOT RECEIVING ANY ALERTS. WHY?

**A:** When the RoboScrub 20 is turned off or a different phone is paired, your phone number will no longer receive alerts. You must pair your phone each day to receive alerts from the RoboScrub 20. This is to ensure that only an on-site operator will receive alerts.

# TROUBLESHOOTING & SUPPORT

## TROUBLESHOOTING TIPS

PROBLEM	CAUSE	RESOLUTION
<b>POOR OR NO WATER PICK-UP</b>	Worn or torn squeegee blade	Rotate or replace blade
	Recovery tank full	Empty recovery tank
	Recovery tank drain hose leak	Secure drain hose cap or replace
	Recovery tank lid gasket leak	Replace gasket lid cover properly
	Debris caught in squeegee	Clean squeegee
	Vacuum hose or squeegee outlet clogged	Remove debris and flush hose
	Using too much solution	Adjust solution flow setting
	Recovery hose to squeegee or recovery tank disconnected or damaged	Reconnect or replace recovery hose
<b>POOR SCRUBBING PERFORMANCE</b>	Worn brushes	Rotate or replace brushes
	Wrong brush or cleaning chemical	Consult Minuteman
	Debris caught on scrub brushes	Remove debris
	Moving machine too fast	Slow down
	Not using enough solution	Adjust solution flow setting
	Low battery charge	Recharge batteries
<b>INADEQUATE SOLUTION FLOW OR NO SOLUTION TO THE FLOOR</b>	Solution tank empty	Fill solution tank
	Solution lines, valves, filter, or spray jets clogged	Flush lines and clean solution filter and spray jets
	Scrub deck raised	Press the one-touch button to lower scrub deck
<b>MACHINE NOT OPERATIONAL</b>	Tripped Control Power circuit breaker	Reset breaker
	Low battery charge	Recharge batteries
	Battery charger operating	Unplug battery charger when charge is complete
<b>VACUUM MOTOR DOES NOT TURN ON</b>	Recovery tank full	Empty recovery tank
	Excessive foaming in recovery tank	Empty recovery tank Use a different cleaning chemical Use a lesser amount of the cleaning chemical Use a defoaming agent
	Carbon brushes worn	Replace carbon brushes
	Vacuum switch disconnected	Connect wiring
	Vacuum not turned on	Press vacuum button



# TROUBLESHOOTING & SUPPORT

## TROUBLESHOOTING TIPS (continued)

PROBLEM	CAUSE	RESOLUTION
<b>NO POWER TO MACHINE</b>	Battery Disconnected	Check All Battery Cable Connections
	Emergency Shut-Off Activated	Reset
	Battery Terminals Corroded	Clean Connections
	Faulty Main Connector	Replace Connector
	Faulty Key Switch	Replace Switch
<b>BRUSH DOES NOT UNLOAD</b>	Broken brush motor switch	Replace switch
	Damaged brush block or drive hub	Replace
	Scrub deck not all the way up	Push the one-touch button and wait for the scrub deck to completely raise
<b>NO ROC CONNECTION</b>	Poor cellular signal	Turn the machine off, wait 10 seconds, and turn back on

# TROUBLESHOOTING & SUPPORT

## WHERE TO GET MAINTENANCE AND SUPPORT

If the touch screen displays the following error, reboot the RoboScrub 20. If the problem persists, please contact customer service.



## CUSTOMER SUPPORT

(800) 323 - 9420

[techsupport@minutemanintl.com](mailto:techsupport@minutemanintl.com)

# WARRANTY

## Minuteman International Made Simple Commercial Limited Warranty

### REVISION P EFFECTIVE 5/1/2017

Minuteman International, Inc. warrants to the original purchaser/user that the product is free from defects in workmanship and materials under normal use. Minuteman will, at its option, repair or replace without charge, parts that fail under normal use and service when operated and maintained in accordance with the applicable operation and instruction manuals. All warranty claims must be submitted through and approved by factory authorized repair stations.

This warranty does not apply to normal wear, or to items whose life is dependent on their use and care, such as belts, cords, switches, hoses, rubber parts, brushes, electrical motor components or adjustments. Parts manufactured by Minuteman are covered by and subject to the warranties and/or guarantees of their manufacturers. Please contact Minuteman for procedures in warranty claims against these manufacturers.

**Special warning to purchaser** -- Use of replacement filters and/or pre-filters not manufactured by Minuteman or its designated licensees, will void all warranties expressed or implied. A potential health hazard exists without original equipment replacement.

All warranted items become the sole property of Minuteman or its original manufacturer, whichever the case may be.

Minuteman disclaims any implied warranty, including the warranty of merchantability and the warranty of fitness for a particular purpose. Minuteman assumes no responsibility for any special, incidental or consequential damages.

This limited warranty is applicable only in the U.S.A. and Canada, and is extended only to the original user/purchaser of this product. Customers outside the U.S.A. and Canada should contact their local distributor for export warranty policies. Minuteman is not responsible for costs or repairs performed by persons other than those specifically authorized by Minuteman. This warranty does not apply to damage from transportation, alterations by unauthorized persons, misuse or abuse of the equipment, use of non-compatible chemicals, or damage to property, or loss of income due to malfunctions of the product.

If a difficulty develops with this machine, you should contact the dealer from whom it was purchased.

This warranty gives you specific legal rights, and you may have other rights which vary from state to state. Some states do not allow the exclusion or limitation of special, incidental or consequential damages, or limitations on how long an implied warranty lasts, so the above exclusions and limitations may not apply to you.

# WARRANTY

<b>Model</b>	<b>Parts</b>	<b>Labor</b>	<b>Poly</b>	<b>Travel**</b>
RoboScrub 20	3yrs	3yrs	12yrs	90 days

<i>Stand-alone Battery Chargers:</i>	One year
<i>Replacement Parts:</i>	Ninety days
<i>Batteries:</i>	0-3 months full replacement, 4-12 months pro-rate
<i>Polypropylene Plastic Tanks:</i>	12yr warranty, no additional labor

# ***Minuteman***<sup>®</sup>

*Excellence Meets Clean*

14N845 U.S. Route 20

Pingree Grove, Illinois 60140 USA

(800) 323-9420

[www.minutemanintl.com](http://www.minutemanintl.com)

*A Member of the Hako Group*

